

■ Information

The BST12L series is a small, thin, highly efficient and low noise non-isolated type step down DC-DC converter with 12V input that has been developed for distributed feeding. Output voltage is adjustable from 0.7525V to 5.5V and it can operate up to 85°C of the ambient temp with a minimal derating.

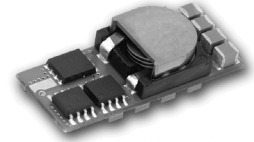

■ Features

- Small and thin type
W=33.0 L=13.4 H=8.3mm
- Non-Isolated type
- SMD
- High efficiency
94.5%, 93.5%, 94.5%
- Wide input voltage range
- Adjustable output voltage
- ON/OFF control
- Under voltage lockout
- Over current protection
- No electrolytic capacitor
- Long life, high-performance,
low price
- Operating temp -40°C to +85°C
(Temp derating required)
- Heatsink not required
- RoHS compliance

■ Model/Rating

Model BST12L Series	Input V Vdc	Output V Vdc	Output I A	Line Reg. % (typ.)	Load Reg. % (typ.)	Noise mVpp (typ.)	Efficiency % (typ.)
BST12L-0.7S10PDM	6.0-14.0	0.7525-5.5	10.0	0.2	0.6	25	94.5
BST12L-0.7S16PDM			16.0		0.8	40	93.5
BST12L-0.7S25PDM			25.0			75	94.5

Table 1

Note1: Ripple noise and efficiency are when input voltage is 12V, output voltage 5V and output current is rated.

Note2: Ripple noise is measured by 20MHz bandwidth with a multi layered ceramic capacitor.

BST12L-0.7S10PDM : 47μF×4 at input, 47μF×2+1μF at output

BST12L-0.7S16PDM/ BST12L-0.7S25PDM : 47μF×4 at input, 47μF×4+1μF at output

Note3: Depending on ambient temp conditions, cooling air flow may be required.

■ Specifications

Table 2

Models	BST12L-0.7S10PDM	BST12L-0.7S16PDM	BST12L-0.7S25PDM	Conditions
Input voltage range	6.0-14.0V (Vout≤3.8Vdc) 8.0-14.0V (Vout>3.8Vdc)			
Rated input voltage	12.0V			
Output voltage anomaly	±1.5% (Output voltage : 0.7525V)			Trim pin Open , Output current 0A
Adjustable output voltage range	0.7525 to 5.5V (may be adjusted by an external resistor)			0.7525V for the default setting
Line regulation	0.2% typ.	0.2% typ.	0.2% typ.	Line regulation varying from 6.0 to 14.0V.
Load regulation	0.6% typ.	0.8% typ.	0.8% typ.	Load varying from 0 to 100%
Total regulation	±2.5% max.	±2.5% max.	±3.0% max.	Inclusive of output voltage anomaly, line, load and temp regulations
Ripple noise	25mVp-p typ.	40mVp-p typ.	75mVp-p typ.	Output voltage 5V, Measurement frequency bandwidth 20MHz
Efficiency	94.5% typ.	93.5% typ.	94.5% typ.	Rated input, Output voltage 5V, Rated output current
	80.0% typ.	79.5% typ.	80.5% typ.	Rated input, Output voltage 1V, Rated output current
Over current protection	Activated at 17A typ. A hick-up mode, Auto-recovery	Activated at 27A typ. A hick-up mode, Auto-recovery	Activated at 33A typ. A hick-up mode, Auto-recovery	Output voltage 3.3V
Over voltage protection	No			
Under voltage lockout	Yes			
Over current protection	No			
Remote ON/OFF control	Between 6 pin (On/Off) and 2 pin (GND) : Output ON when in Open, Output OFF when in Short (Refer to Page 8)			
Standby Current	2.5mA typ.			
Remote sensing	Yes			
Max output load capacity	5000μF max (ESR>10mΩ), 1000μF max (ESR>1mΩ)			
Operating temp range	-40°C to +85°C (Refer to the separate temp derating chart)			
Humidity range	20 to 85% R.H. (No condensation)			
Storing temp range	-55°C to +125°C			
Storing conditions	Before mounting a converter : 30°C/60% R.H. or lower with less than 1 year (After opening moisture-proof packaging)			
Cooling conditions	A cooling air flow may be required depending on the ambient temp. Refer to the separate derating chart.			
Vibrations	5-10Hz, all amplitude 10mm p-p, 5-55Hz acceleration 4m/s ² (2 hours in each of 3 orthogonal axes)			
Shock	Acceleration 50m/s ² , 11m/s, Half sine Wave (3 directions, 3 times each)			
Weight	6.7g typ.			
Dimensions	W=33.0 L=13.4 H=8.3 typ. (mm) *For further details, please refer to Page 6.			

*The above information is stated with rated value at 25°C of normal temp, unless otherwise specified.

1. Usage range

The datasheet applies to a direct input, non-isolated type DC-DC converter, BST12L Series.

2. Model name/Rating

Table 3

Models	Rated input voltage	Output voltage	Rated output current	Shapes
BST12L-0.7S10PDM	DC 12.0V	0.7525V to 5.5V	10A	SMD
BST12L-0.7S16PDM			16A	
BST12L-0.7S25PDM			25A	

The default setting of output voltage is $0.7525V \pm 1.5\%$.

Input/output is rated with the ambient temp $25^{\circ}\text{C} \pm 5^{\circ}\text{C}$, unless otherwise specified in the datasheet.

3. Environmental conditions

3-1. Temp range

Active -40°C to $+85^{\circ}\text{C}$ (Temp derating required, refer to section 9)

Storage -55°C to $+125^{\circ}\text{C}$

3-2. Humidity range

Active 20 to 85%RH (No condensation)

Storage 5 to 85%RH (No condensation)

4. Specification/Rating

The product complies with RoHS.

4-1 Absolute maximum rating

Absolute maximum rating is the rating when the product is overworked. Excessive stress to the product can cause permanent damage. If the product is used under the absolute maximum rating for a long period of time, the credibility of the product could be damaged. Therefore, please use the product under the conditions specified in the electrical characteristics chart [4-2].

Table 4

Items	code	min.	max.	units
Input voltage	Vin	-0.3	15	V
Output voltage	Vout	0.7525	5.5	V
Operating temp range	Ta	-40	85	$^{\circ}\text{C}$
Storing temp	Tstg	-55	125	$^{\circ}\text{C}$

4-2. Electrical characteristics

4-2-1. Electrical characteristics BST12L-0.7S10PDM

(Ta=25°C, Airflow=200LFM(1.0m/s), Vin=12.0V, Vout=0.7525-5.5V, Io=Rated, unless otherwise specified in the conditions)

Table 5

Item	Code	Conditions	min.	typ.	max.	Units
Input characteristics						
Input voltage range	Vin	Vout = 3.8V (3.3V+15%)	6.0	12.0	14.0	V
		Vout > 3.8V (3.3V+15%)	8.0	12.0	14.0	V
UVLO turn-on voltage				5.5	6.0	V
UVLO turn-off voltage			4.0	4.4		V
Max input current	lin	Vin = 8.0V Vout = 5.0V Io = 10A			6.6	A
Input current at no-load	lin	Vout = 5.0V Io = 0A		75		mA
Standby current	lin			2.5		mA
Recommended input capacity	Cin	47μF × 4 min.	188		1200	μF
Output characteristics						
Output voltage setting anomaly	Vout	Vin = 12.0V Io = 0A	-1.5	Vout	+1.5	%Vout
Adjustable output voltage range	Vout		0.7525		5.5	V
Line regulation		Vin = 8.0V ~ 14.0V Io = 10A		0.2		%Vout
Load regulation		Io = 0A ~ 10A		0.6		%Vout
Total regulation		Inclusive of output voltage setting anomaly, input, load, temp regulations	-2.5		+2.5	%Vout
Output current (Temp derating required)	Io		0		10.0	A
Over current protection	Io	Vout = 3.3V		17		A
Output overshoot at turn-on		Remote ON / Input ON			2	%
Recommended output capacity	Co	47μF × 2 min.	94			μF
Max output load capacity	Co	ESR > 1mΩ ESR > 10mΩ			1000 5000	μF
Output ripple noise						
Vout = 5.0V Vout = 1.0V		Bandwidth = 20MHz Cin = 47μF×4, Cout = 47μF×2 + 1μF		25 10	80 80	mVp-p
Efficiency						
Vo = 5.0V Vo = 1.8V Vo = 1.0V	η	Vin=12.0V Io=10A		94.5 87.5 80.0		%
Others, features and characteristics						
Switching frequency				320		kHz
Remote ON/OFF control Logic High Voltage Logic Low Voltage		Module On, Von/off Module Off, Von/off	Vin-1.0 -5.0		Vin Vin-2.7	V V
Overheat protection				120		°C
Weight				6.7		g

4-2-2. Electrical characteristics BST12L-0.7S16PDM

(Ta=25°C, Airflow=200LFM(1.0m/s), Vin=12.0V, Vout=0.7525-5.5V, Io=Rated, unless otherwise specified in the conditions)

Table 6

Item	Code	Conditions	min.	typ.	max.	Units
Input characteristics						
Input voltage range	Vin	Vout = 3.8V (3.3V+15%)	6.0	12.0	14.0	V
		Vout > 3.8V (3.3V+15%)	8.0	12.0	14.0	V
UVLO turn-on voltage				5.5	6.0	V
UVLO turn-off voltage			4.0	4.4		V
Max input current	Iin	Vin = 8.0V Vout = 5.0V Io = 16A			10.7	A
Input current at no-load	Iin	Vout = 5.0V Io = 0A		75		mA
Standby current	Iin			2.5		mA
Recommended input capacity	Cin	47μF × 4 min.	188		1200	μF
Output characteristics						
Output voltage setting anomaly	Vout	Vin = 12.0V Io = 0A	-1.5	Vout	+1.5	%Vout
Adjustable output voltage range	Vout		0.7525		5.5	V
Line regulation		Vin = 8.0V ~ 14.0V Io = 16A		0.2		%Vout
Load regulation		Io = 0A ~ 16A		0.8		%Vout
Total regulation		Inclusive of output voltage setting anomaly, input, load, temp regulations	-2.5		+2.5	%Vout
Output current (Temp derating required)	Io		0		16.0	A
Over current protection	Io	Vout = 3.3V		27		A
Output overshoot at turn-on		Remote ON / Input ON			2	%
Recommended output capacity	Co	47μF × 4 min.	188			μF
Max output load capacity	Co	ESR > 1mΩ ESR > 10mΩ			1000 5000	μF
Output ripple noise						
Vout = 5.0V Vout = 1.0V		Bandwidth = 20MHz Cin = 47μF×4, Cout = 47μF×4+1μF		40 12	80 80	mVp-p
Efficiency						
Vo = 5.0V Vo = 1.8V Vo = 1.0V	η	Vin=12.0V Io=16A		93.5 86.5 79.5		%
Others, features and characteristics						
Switching frequency				320		kHz
Remote ON/OFF control Logic High Voltage Logic Low Voltage		Module On, Von/off Module Off, Von/off	Vin-1.0 -5.0		Vin Vin-2.7	V V
Overheat protection				120		°C
Weight				6.8		g

4-2-3. Electrical characteristics BST12L-0.7S25PDM

(Ta=25°C, Airflow=200LFM(1.0m/s), Vin=12V, Vout=0.7525-5.5V, Io=Rated, unless otherwise specified in the conditions)

Table 7

Item	Code	Conditions	min.	typ.	max.	Units
Input characteristics						
Input voltage range	Vin	Vout = 3.8V (3.3V+15%)	6.0	12.0	14.0	V
		Vout > 3.8V (3.3V+15%)	8.0	12.0	14.0	V
UVLO turn-on voltage				5.5		V
UVLO turn-off voltage				4.4		V
Max input current	Iin	Vin = 8.0V Vout = 5.0V Io = 25A			16.5	A
Input current at no-load	Iin	Vout = 5.0V Io = 0A		85		mA
Standby current	Iin			2.5		mA
Recommended input capacity	Cin	47μF × 4 min.	188			μF
Output characteristics						
Output voltage setting anomaly	Vout	Vin = 12.0V Io = 0A	-1.5	Vout	+1.5	%Vout
Adjustable output voltage range	Vout		0.7525		5.5	V
Line regulation		Vin = 8.0V ~ 14.0V Io = 25A		0.2		%Vout
Load regulation		Io = 0A ~ 25A		0.8		%Vout
Total regulation		Inclusive of output voltage setting anomaly, input, load, temp regulations	-3.0		+3.0	%Vout
Output current (Temp derating required)	Io		0		25.0	A
Over current protection	Io	Vout = 3.3V		33		A
Recommended output capacity	Co	47μF × 4 min.	188			μF
Max output load capacity	Co	ESR > 1mΩ ESR > 10mΩ			1000 5000	μF
Output ripple noise						
Vout = 5.0V Vout = 1.0V		Bandwidth = 20MHz Cin = 47μF×4, Cout = 47μF×4+1μF		75 25	150 80	mVp-p
Efficiency						
Vo = 5.0V Vo = 1.8V Vo = 1.0V	η	Vin=12.0V Io=25A		94.5 87.5 80.5		%
Others, features and characteristics						
Switching frequency				320		kHz
Remote ON/OFF control Logic High Voltage Logic Low Voltage		Module On, Von/off Module Off, Von/off	Vin-1.0 -5.0		Vin Vin-2.7	V V
Overheat protection				120		°C
Weight				7.0		g

4-3. Measurement circuits

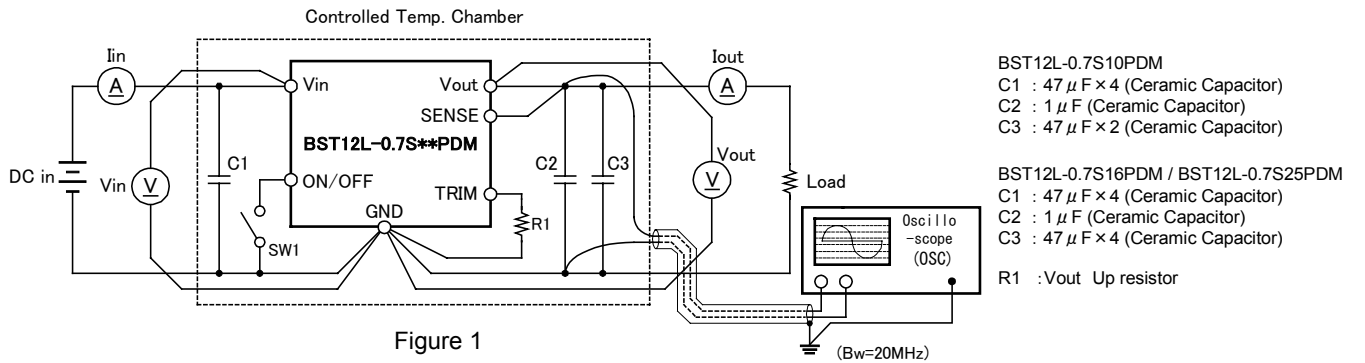

Figure 1

5. Outer dimensions and pin information

5-1. Configurations/Dimensions

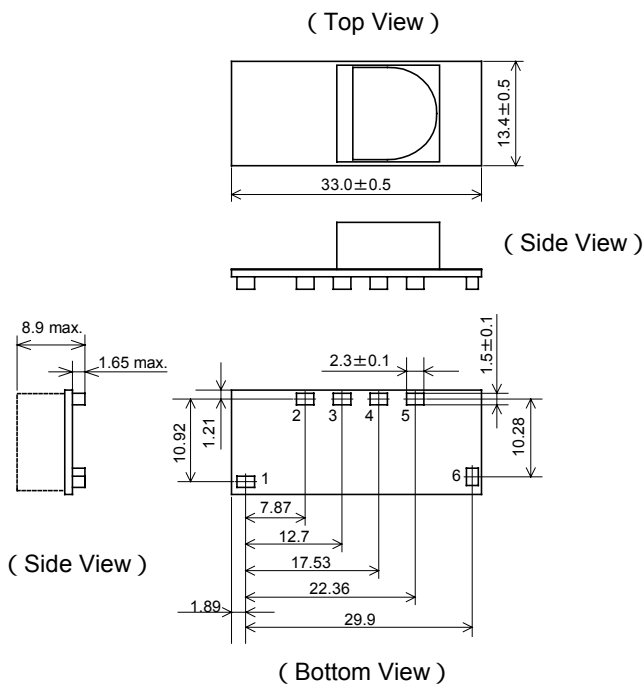

Figure 2

Table 8

Pin	Name	Function
1	Vin	+ Input pin
2	GND	Input/output GND pin
3	Vout	+ Output pin
4	TRIM	Adjustable output voltage pin
5	SENSE	Sensing pin
6	ON/OFF	Remote ON/OFF control pin

Pin numbers are not indicated on the product.

Pin material : Copper
 Coat on the pins : Gold plate after plated with Nickel

- Units mm
- Tolerances unless otherwise specified \pm 0.25
- Weight = 6.7g typ.
 (BST12L-0.7S10PDM)
- Weight = 6.8g typ.
 (BST12L-0.7S16PDM)
- Weight = 7.0g typ.
 (BST12L-0.7S25PDM)

5-2. Recommended pad dimension diagram

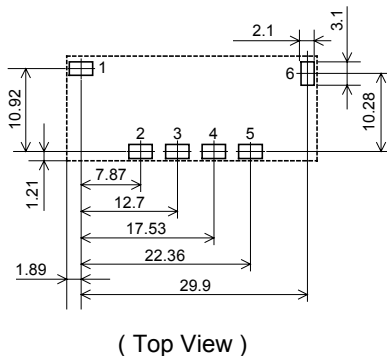

(Top View)

Figure 3

5-3. Model name/Year and Month of manufacturing display

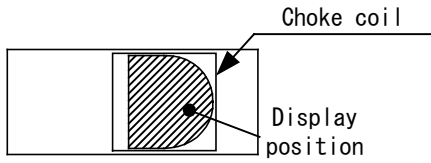

Figure 4

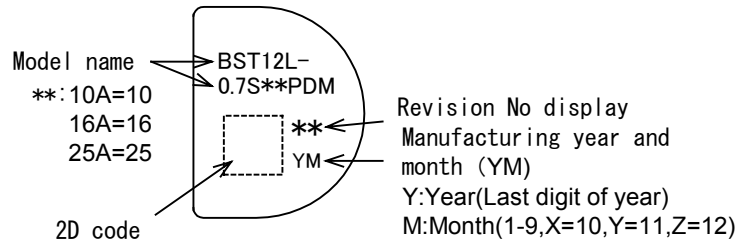

Figure 5

6. Usage

6-1. Standard connection circuit

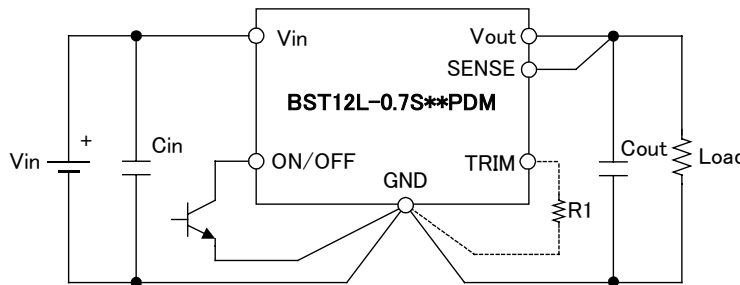

Figure 6

BST12L-0.7S10PDM
 Cin : $47 \mu\text{F} \times 4$ (Ceramic Capacitor)
 Cout : $47 \mu\text{F} \times 2 + 1 \mu\text{F}$ (Ceramic Capacitor)
 BST12L-0.7S16PDM / BST12L-0.7S25PDM
 Cin : $47 \mu\text{F} \times 4$ (Ceramic Capacitor)
 Cout : $47 \mu\text{F} \times 4 + 1 \mu\text{F}$ (Ceramic Capacitor)
 R1 : Vout Up resistor

6-2. Input filter

Input power supply to the BST12L series should be provided with low impedance.

High impedance on the input side may cause some stability issues to the module. Therefore, since an added capacitor (Cin) requires a low ESR capacitor, a multi-layered ceramic capacitor is recommended. Please use the capacity and number of pieces indicated in the standard connection circuit [6-1]. When impedance on the input side is especially high, such as long wiring, capacitors other than the recommended capacitors are required to be added. The capacitor (Cin) should be connected near to the module.

When several converters with the switching method operate with the same electrical power source or by a cascade connection, they interact with each other and will have an effect of beat frequency that could appear in output voltage or a beat sound. When using these connections, L-C filters need to be made.

6-3. Remote ON/OFF control

Output voltage may be controlled by ON/OFF feature without switching on and off the input. The ON/OFF pin is pulled-up by V_{in} inside the module. When not using the ON/OFF control, leave the ON/OFF pin open or connect to V_{in} .

Between ON/OFF (6pin) and GND (2pin)
 OPEN : Output ON
 SHORT : Output OFF

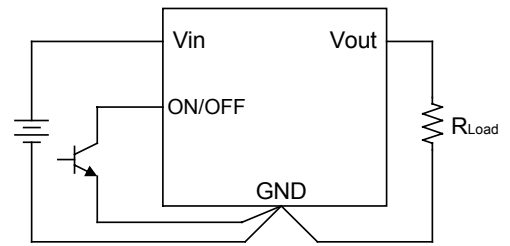

Figure 7

A device used for the ON/OFF control should have a sink capability of around 0.3mA in the Low level.

6-4. Sensing feature

The BST12L series has a remote sensing feature that corrects the voltage drop due to the wiring between V_{out} pin and Load. Since the product is a non-isolated type that has a common input/output GND, sensing can be only used for +output. Remote sensing line is a part of the feed back loop and has a small amount of current flowing. Care needs to be taken when wiring the patterns and completing the lay out.

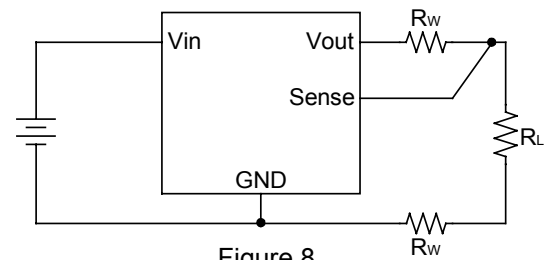

Figure 8

6-5. Output voltage programming

The BST12L series may adjust to any output voltage within the range of 0.7525V to 5.5V.

Please note that the input voltage range may vary depending on the output voltage. Please refer to the electrical characteristics [Section 4-2].

When the TRIM pin is open, the output voltage is $0.7525V \pm 1.5\%$.

There are two methods to adjust output voltage. One is by an external voltage and the other is by an external resistive connection.

6-5-1. Adjustable methods by an external voltage

Output voltage, Vout may be adjusted by applying an external voltage between the TRIM and GND pins as in Figure 9.

The output voltage, Vout may vary to slight change of VCTRL voltage with only external power supply of VCTRL (REXT=0Ω).

Connecting a resistor, REXT between the TRIM pin and the external power supply in series should be recommended to prevent this

The formula for the adjustable external voltage VCTRL of the BST12L series is as follows.

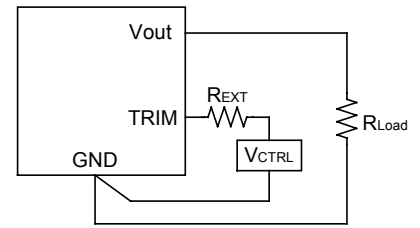

Figure 9

$$V_{CTRL} = 0.7 - \frac{(1 + R_{EXT} [k\Omega])(V_{out} - 0.7525)}{15} [V]$$

e.g.) The formula of VCTRL for setting Vout to 3.3V (REXT=15kΩ) is as follows.

$$V_{CTRL} = 0.7 - \frac{(1 + 15)(3.3 - 0.7525)}{15} = -2.017V$$

E.g. for voltage control Table 9

Vout (V)	VCTRL (V)	
	REXT=0Ω	REXT=15kΩ
0.7525	OPEN or 0.700	OPEN or 0.700
1.0	0.684	0.436
1.2	0.670	0.223
1.5	0.650	-0.097
1.8	0.630	-0.417
2.0	0.617	-0.631
2.5	0.584	-1.164
3.3	0.530	-2.017
5.0	0.417	-3.831
5.5	0.384	-4.364

6-5-2. Adjustable methods by an external resistor

Output voltage, Vout may be adjusted by connecting a resistor between the TRIM and GND pins as in Figure 10.

The formula for the adjustable resistor, RTRIM of the BST12L series is as follows.

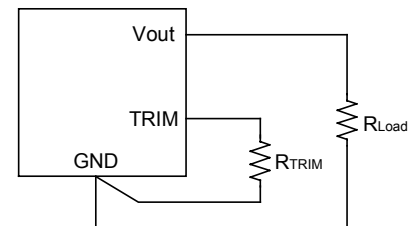

Figure 10

$$R_{TRIM} = \frac{10.5}{(V_{out} - 0.7525)} - 1 [k\Omega]$$

e.g.) The formula of RTRIM for setting Vout to 3.3V is as follows.

$$R_{TRIM} = \frac{10.5}{(3.3 - 0.7525)} - 1 = 3.12k\Omega$$

e.g. for adjustable resistance control Table 10

Vout (V)	RTRIM [kΩ]	Approximate value of RTRIM when using the resistor in THE E96 line [kΩ]*
0.7525	OPEN	—
1.0	41.42	41.2
1.2	22.46	22.6
1.5	13.05	13.0
1.8	9.02	9.09
2.0	7.42	7.50
2.5	5.01	4.99
3.3	3.12	3.09
5.0	1.47	1.47
5.5	1.21	1.21

*There may be a slight difference in Vout value because of the approximate values.

After working out the external resistance, make sure to check the output voltage and adjust the resistance value. The tolerances of RTRIM will affect to the tolerances of the output voltage.

7. Overheat protection

When the BST12L series is used under adverse condition, it will go into the overheat state and stop operating automatically. When the temperature goes back to normal, it will recover itself. (Auto-reset).

8. Over current protection

The converter protects itself against over current and short circuits. When it goes into the over heat state, it will go into the pulse-by-pulse and hick-up modes. When the over current state is released, the output voltage will go back to normal. (Auto-reset). Please refrain from using the product for a long period of time under the over current or load circuit conditions that could result in damaging the converter.

9. Temperature derating

Although the converter will operate in a wide range of temperatures, a cooling airflow will be required to release heat when the ambient temp is high.

Please refer to Page 11 in regards to the temp. derating curve that will support the thermal design to use the converter properly.

Measuring in the actual usage environment will be recommended for certain cooling. Especially, when the load in the actual use is close to maximum value of the temp derating, the measurement is required. Make sure that the parts temperatures do not exceed 120°C when used. Figure 11 shows the appropriate parts when measuring temperatures.

Figure 13 to 21 show the max output current under the conditions of the designated environmental temperature and air-cooling. The product is placed horizontally and the wind direction is as in Figure 12.

The air-cooling condition is 100LFM 0.5m/sec.

[Maximum output current]

The value of maximum output current under given conditions will be either 1) or 2), whichever the current value is smaller.

- 1) Output current when the temperature of any parts reaches to 120°C
- 2) The official rated current value of the converter

[Measurement condition]

The temp. derating curve will be defined under the following conditions.

Board : Size 110 x 100mm, t1.6, 4 layers (Copper foil inner layer 70μF, outer layer 70μF)

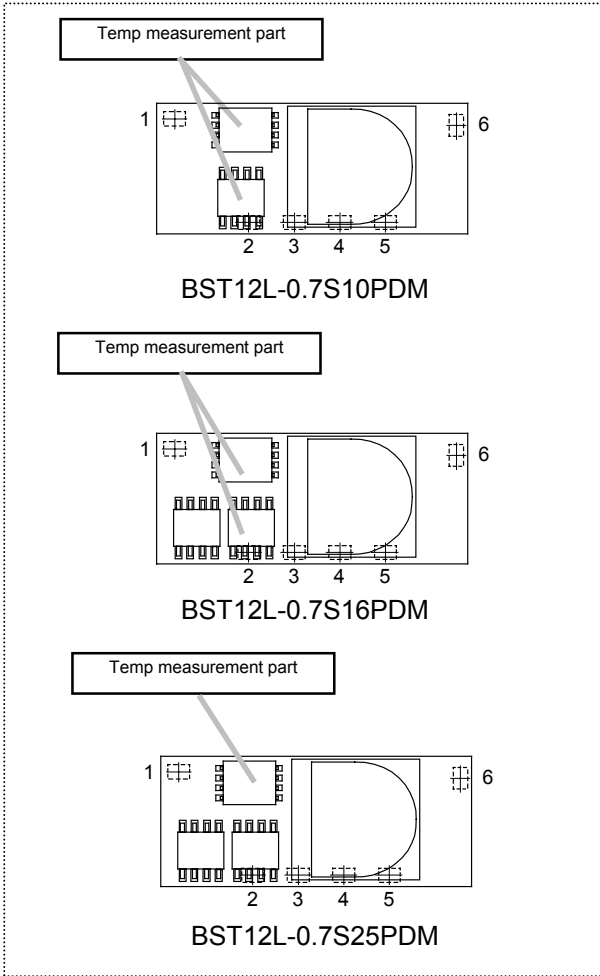

Figure 11. Temp measurement point

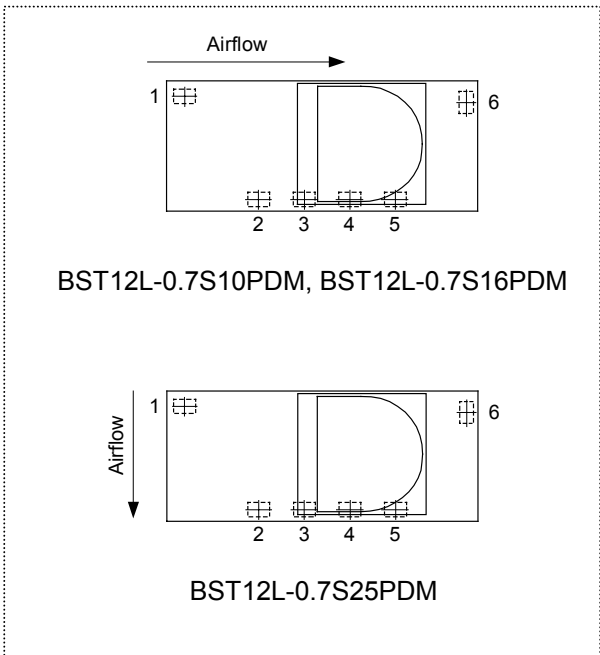

Figure 12. Temp derating air-cooling direction

9-1. BST12L-0.7S10PDM Temp derating curve

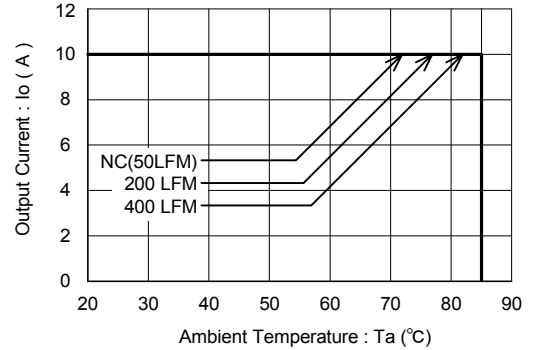

Figure13 BST12L-0.7S10PDM($V_{in}=12.0V$, $V_o=5.0V$)

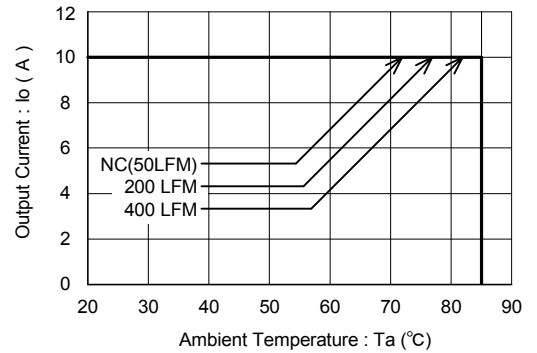

Figure14 BST12L-0.7S10PDM($V_{in}=12.0V$, $V_o=3.3V$)

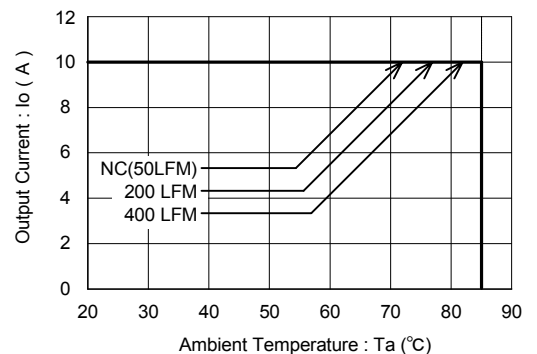

Figure15 BST12L-0.7S10PDM ($V_{in}=12.0V$, $V_o=1.0V$)

9-2. BST12L-0.7S16PDM Temp derating curve

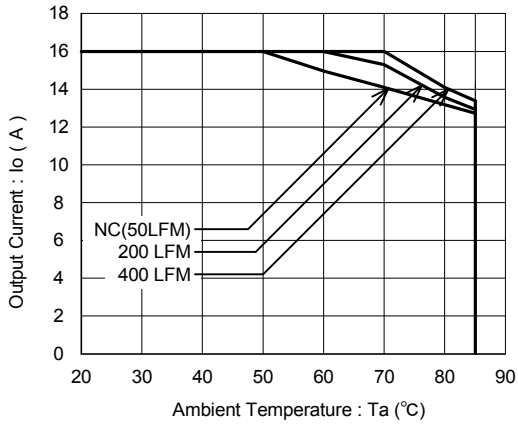

Figure16 BST12L-0.7S16PDM(Vin=12.0V, Vo=5.0V)

9-3. BST12L-0.7S25PDM Temp derating curve

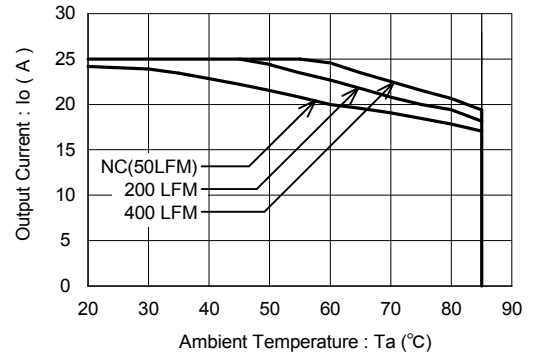

Figure19 BST12L-0.7S25PDM (Vin=12.0V, Vo=5.0V)

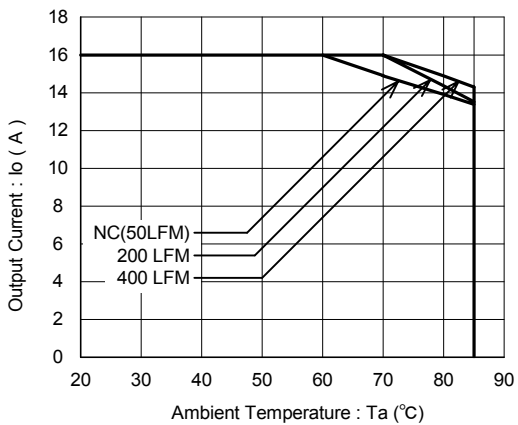

Figure17 BST12L-0.7S16PDM(Vin=12.0V, Vo=3.3V)

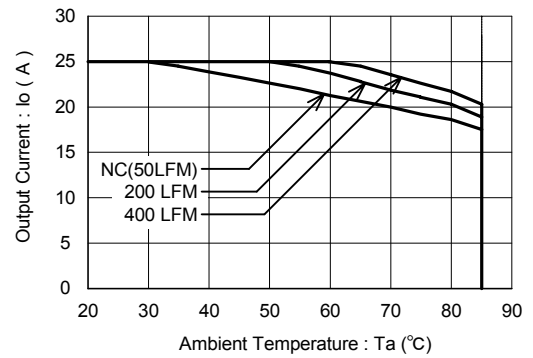

Figure20 BST12L-0.7S25PDM (Vin=12.0V, Vo=3.3V)

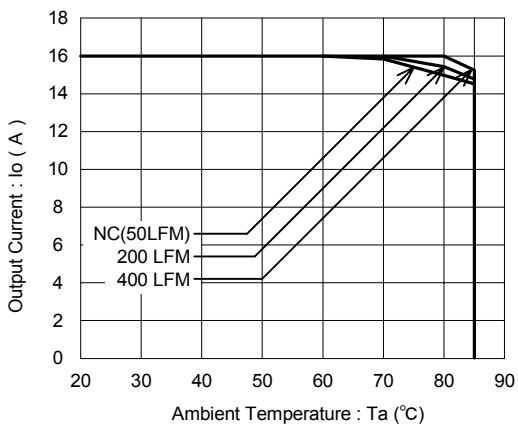

Figure18 BST12L-0.7S16PDM(Vin=12.0V, Vo=1.0V)

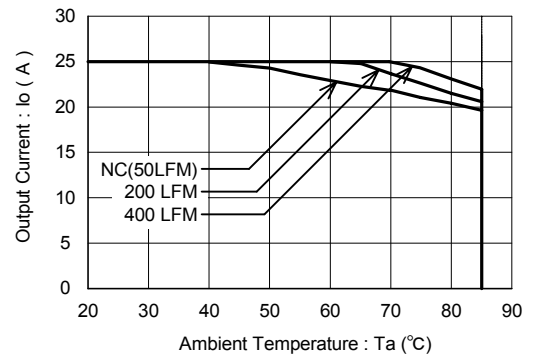

Figure21 BST12L-0.7S25PDM(Vin=12.0V, Vo=1.0V)

10. Protection method of input power supply against reverse connection

The product is a non-isolated type between input and output and step down converter from a straight polarity to a straight polarity. It will be damaged if input polarity is connected in reverse. When there is a possibility of reverse connection, please add a protection circuit as in the below figure.

The below figure is an example of using fuse and diode. The power supply on the supply side should have enough capacity to meltdown a fuse.

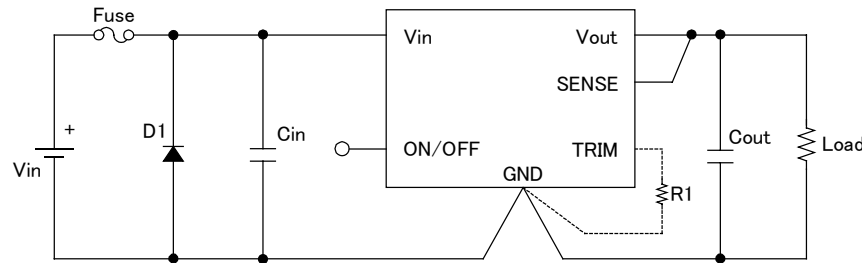

Figure 22

11. Over voltage protection (Example)

The product does not have over voltage protection built in.

When the product is damaged due to the short mode in the internal switch element, the DC input voltage will appear in output as is. Therefore, just in case the over voltage mode will be damaged, please add the input shutoff circuit as in the below figure.

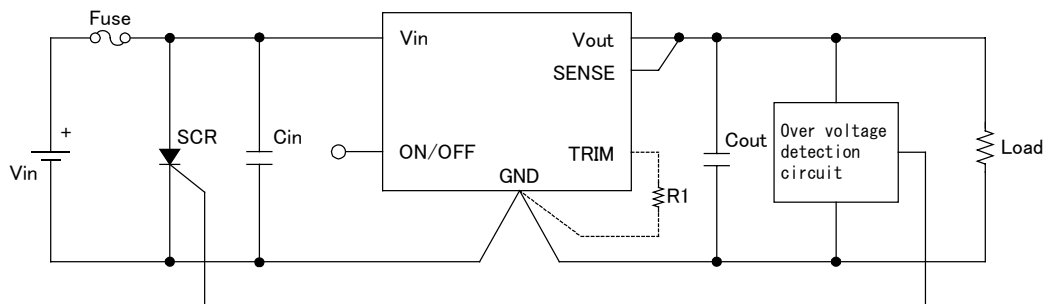

Figure 23

*1 When the product is damaged due to the over voltage mode, the ON/OFF control will not function.

*2 When there is ON/OFF control on the electrical supply side, over voltage protection circuit will be used.

*3 The DC power supply on the electrical supply side should have enough capacity to meltdown a fuse.

12. Mounting conditions

The product may be soldered by the re-flow method. Make sure not to cause the product to vibrate during the re-flow.

This product can not be soldered on by flow.

The re-flow temp profile is as follows (Figure 24).

The number of re-flow will be limited to twice.

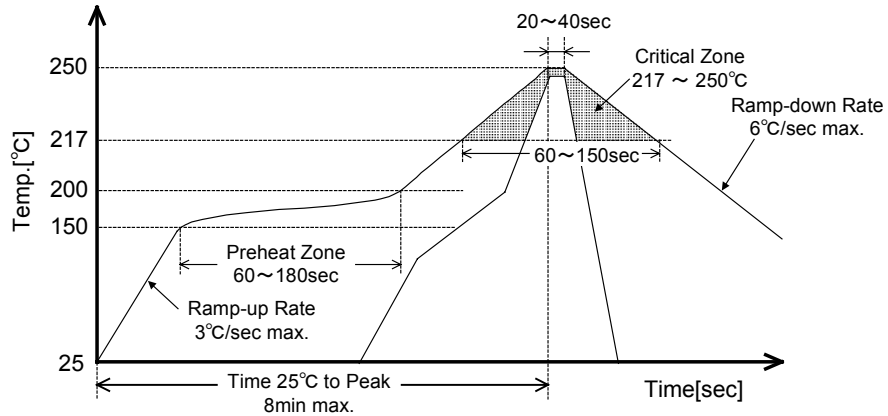

Figure 24. Re-flow temp profile (lead-free product)

13. About washing

The product can not be washed as a whole, although a non scrub flux is recommended.

14. Precautions

For the safety of our customer, please follow all warnings and specifications which are stated below.

- This product is intended for use in general electronic appliances (office work machines, telecommunication equipment, and measurement equipments). Do not use for medical equipments, nuclear power equipments, and trains, etc. where the malfunction and damage of this product may directly cause harm to human life and/or property. Please confirm when using except in general electronic equipment.
- For this product, serial and parallel operations are not possible.
- For mounting this product, please do not use connectors or sockets. The performance may not be fulfilled by the effect of contacting resistors. Mount onto the PCB by soldering.
- This product has a built-in over current, short circuit protection, however long time usage in short circuit should be avoided since this may cause failure to the product.
- This product may be damaged if used under nonstandard electric and environmental conditions such as the temperature. Please be sure to always use within the standard conditions.
- Please refrain from using and storing the product where corrosive gas may be generated. Dust may cause problems so store in a dust free environment.
- There is a possibility that the product may be damaged from static electricity. The workers should discharge all static electricity before handling the product, and the work atmosphere should also have a static countermeasure.
- This product does not have a fuse built in. When abnormal, please connect a fuse into +input line as a protection of over current. The electrical supply source should have enough capacity to be able to shut down a fuse.
- This product does have a built-in over voltage protection, however when the module malfunctions and over voltage occur, the over voltage protection installed will not activate. Therefore, an over voltage protection circuit should always be connected.
- No test certificate is attached to this product.

15. Warranty

The warranty period for this product is one year. If any defects occur in which our company's design or production is to blame during the period, we will either fix the product or trade with a new one, free of charge.

However, the warranty is voided if the product has been internally modified or adjusted.

The warranty covers only the stated products in this datasheet.

16. If you have any further technical questions for this product, please contact us.

E-mail: info@bellnix.com

<http://www.bellnix.com>